

# AccuForce 12V - 100Ah | VRLA Battery



## Specifications

Nominal Voltage	12 V	
Number of cells	6	
Design Life	10 years	
Dimensions	Length	330 mm
	Width	171 mm
	Height	214 mm
	Total Height	220 mm
Approx. Weight	27.5 kg	
	20 hours rate (5.25 A, 10.8 V)	105.0 Ah
Nominal Capacity (25°C)	10 hours rate (10.00 A, 10.8 V)	100.0 Ah
	5 hours rate (17.50 A, 10.5 V)	87.5 Ah
	1 hour rate (62.00 A, 9.6 V)	62.0 Ah
	800 A (5s)	
Max. Discharge Current (25°C)	800 A (5s)	
Internal Resistance	4.5 mOhms	
Fully Charged battery (25°C)		
Self-Discharge	3% of capacity declined per month at 20°C (average)	
Operating Temperature Range	Discharge	-15°C~50°C
	Charge	-10°C~50°C
	Storage	-20°C~50°C
Short Circuit Current	2745 A	
	Cycle use	2.40-2.45 Vpc
Charge Methods:	Maximum charging current	30 A
	Temperature compensation	-30 mV/°C
	Standby use	2.23-2.27 Vpc
	Temperature compensation	-18 mV/°C

## Applications

- Uninterruptible Power Supplies (UPS)
- Electric Power Systems (EPS)
- Emergency backup power supplies
- Electronic apparatus and equipment
- Communication power supplies
- DC power supplies
- Auto control system

## Battery Construction

Component	Positive Plate	Negative Plate	Container	Cover	Safety Valve	Terminal	Separator	Electrolyte
Raw material	Lead dioxide	Lead	ABS	ABS	Rubber	Copper	Fiberglass	Sulfuric acid

## Dimensions

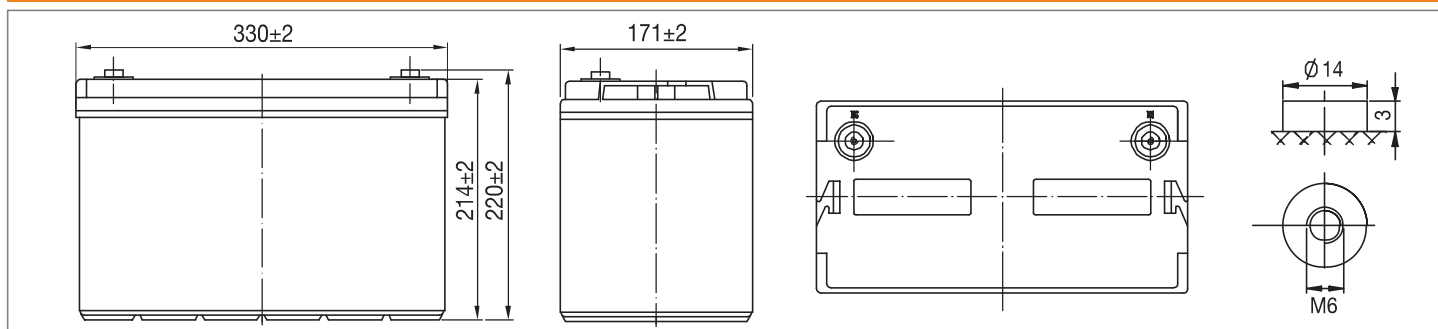

## Constant Current Discharge (Amperes) at 25°C

End Voltage (Volts/Cell)	10min	15min	30min	1h	2h	3h	4h	5h	8h	10h	20h
1.60 V	210	165	100	62.0	36.5	25.5	20.9	17.9	12.2	10.2	5.34
1.65 V	204	161	98.0	61.1	36.3	25.4	20.8	17.7	12.2	10.2	5.33
1.70 V	195	155	95.0	59.5	36.0	25.2	20.6	17.6	12.1	10.1	5.32
1.75 V	187	150	92.7	58.3	35.5	25.0	20.5	17.5	12.0	10.1	5.29
1.80 V	176	142	89.3	56.5	34.6	24.3	19.9	17.0	11.6	10.0	5.25

## Constant Power Discharge (Watts) at 25°C

End Voltage (Volts/Cell)	10min	15min	30min	1h	2h	3h	4h	5h	8h	10h	20h
1.60 V	2268	1812	1122	707	423	300	246	211	145	122	64.1
1.65 V	2200	1768	1100	696	421	298	244	210	145	121	64.0
1.70 V	2109	1703	1066	679	417	296	243	208	144	121	63.8
1.75 V	2019	1645	1040	665	411	294	241	207	143	120	63.4
1.80 V	1905	1558	1002	645	400	285	234	201	138	119	63.0

# AccuForce 12V - 100Ah | VRLA Battery

### Temperature Effects on Float Life

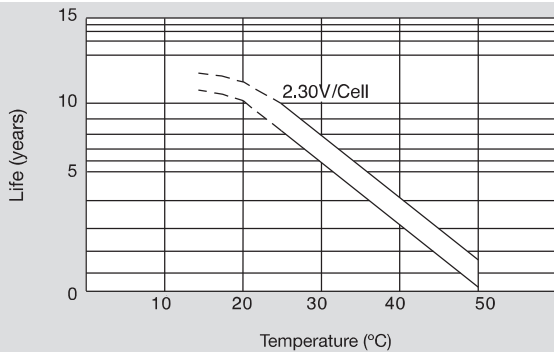

### Self Discharge Characteristics

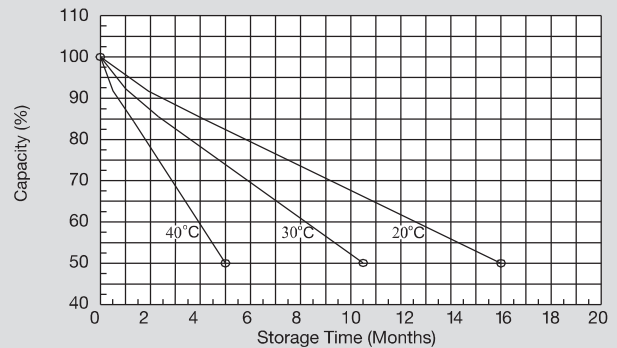

### Discharge Characteristics (25°C)

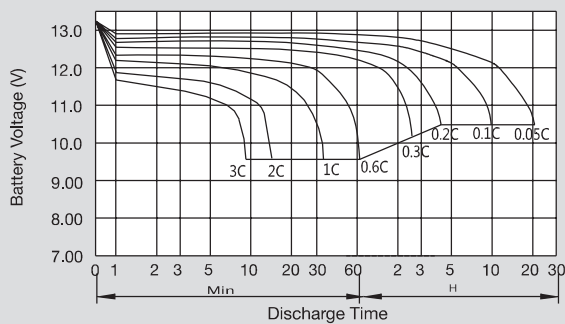

### Constant Voltage Charging Characteristic (0.25 CA, 25°C)

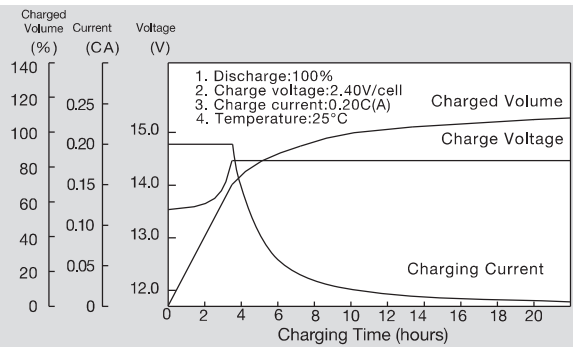

### Relationship Between Charging Voltage and Temperature

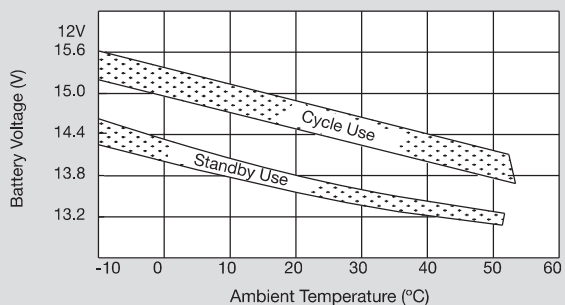

### Relationship Between OCV and Residual Capacity (25°C)

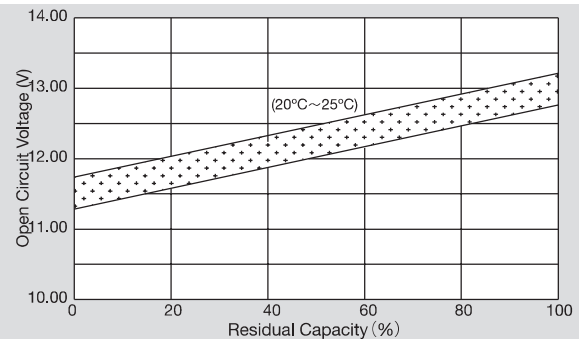

### Cycle Service Life in Relation to Depth of Discharge

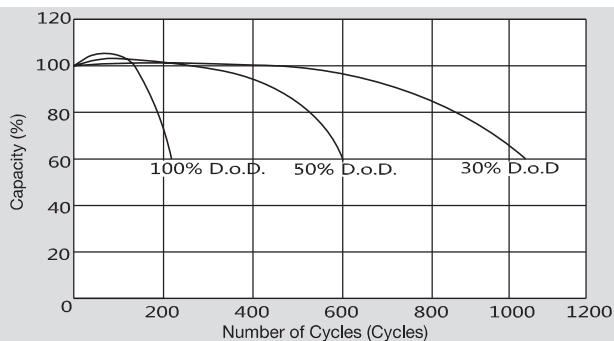

### Temperature Effects on Capacity

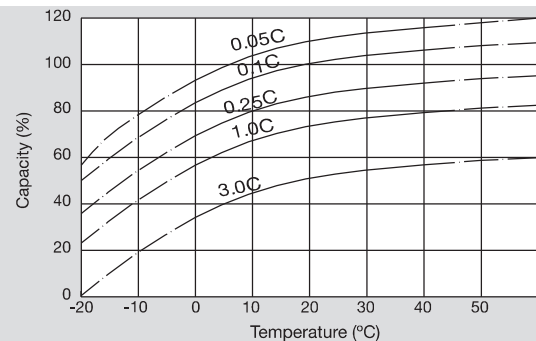

## SYSTEMS SUNLIGHT S.A.

### Headquarters

2 Ermou & Nikis Str., Syntagma Sq.  
105 63 Athens, Attica, Greece

T +30 210 6245400 F +30 210 6245409

### European Manufacturing Plant

672 00 Nefi Olvio, Xanthi, Greece

### Global Service Department

90 Tatoiou Str.  
136 73 Acharnes, Attica, Greece